

Galaxy series downlight is a perfect choice for hotel lighting and hospitality area.

it consists of two interchangeable versions.

- Clear glass version makes the LED light source deep recessed, which provides very low glare light.
- Diffused cover version can provide very uniform light output.



INTERCHANGEABLE DESIGN WITH CONCEPT

Reduce your stock for too many different LED downlights

CITIZEN COB LED: long lifetime and high lighting quality;

COB Holder: smart design, soldering-free when changing different color temperature of LED.

Primary reflector: twist&lock design,easy to change clear glass version and diffused cover version

Secondary reflector: press& fix,easy to change different color,fulfilling lighting design and aesthetic requirement in flexible way

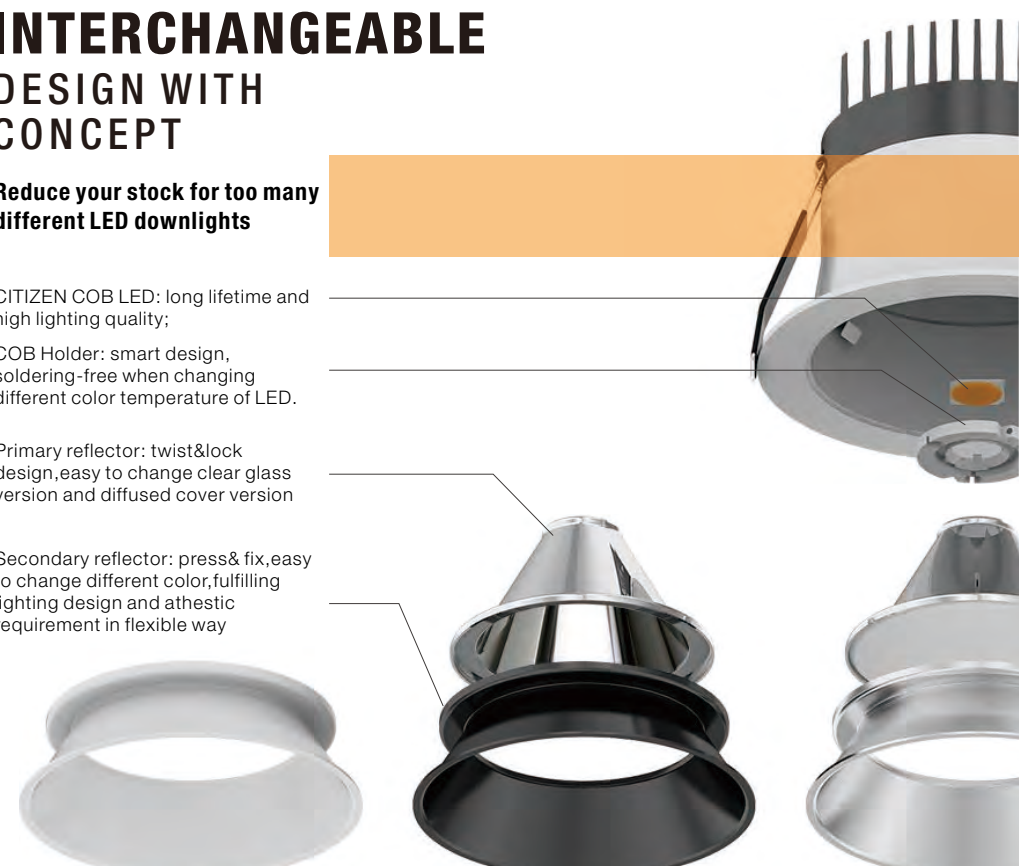



G4
(800 Lm)
(1000 Lm)



G5
(1,000 Lm)
(1,500 Lm)



G6
(1,700 Lm)
(2,300 Lm)



G7
(1,700 Lm)
(2,300 Lm)



G8
(2,300 Lm)
(3,300 Lm)



Clear glass version

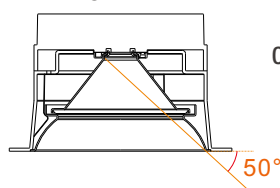

Clare cut-off Angle 50°
UGR < 19

Interchangeable Accessory

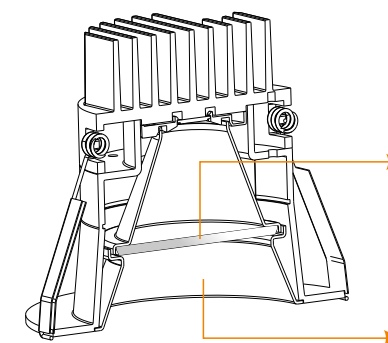

Primary Reflector Type



Diffused cover version Clear glass version

Secondary Reflector



Silver Reflector (Standard) White Reflector (Option) Black Reflector (Option)



Diffused cover version



Clear glass version

Function

- The smallest size in Galaxy series:90mm cutout. Perfect choice for hotel lighting and hospitality area
- Thanks to its zhaga concept designs,G4R owns high flexibility in change of reflector and LED, customer can change different accessory for different application without tool.
- Clear glass version makes the LED light source deep recessed, which provides very low glare light
- Diffused cover version can provide very uniform light output.
- Three color options for secondary reflector:Silver,Black and White - High quality CITIZEN COB chip and LED driver
- Easy replacement of 18W CFL downlight and 50W halogen



- Ambient operating temperature: -20°C~+40°C
- Storage temperature: -30°C~+60°C

LED Driver

External Driver (CE/CB/SAA certificated)
Non-Dim: standard
Phase Dim: optional
1-10V /Touch /DALI Dim: on project request

Primary Reflector Type



Diffused cover

Clear glass

Secondary Reflector



Silver Reflector (Standard)

White Reflector (Option)

Black Reflector (Option)

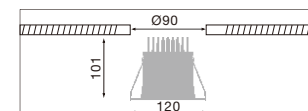

Diffused cover version



Clear glass version

9.5 W 800 lm-1000lm

3000K (Standard)

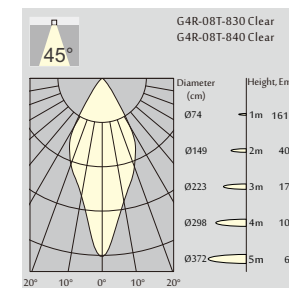
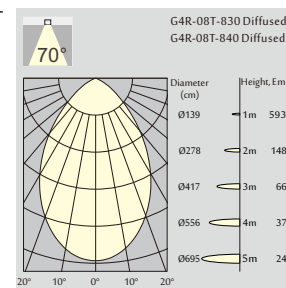

Order Information

G4R with diffused cover version

G4R-08T 800 Lm MODELS (White trim, CITIZEN LED)						
Code	LED output	Downlight output	LED Power	System Power	CRI	CCT
G4R-08T-830 Diffused	1100 lm	800 lm	9.5 W	12 W	83	3000K
G4R-08T-840 Diffused	1200 lm	850 lm	9.5 W	12 W	83	4000K

G4R with clear glass version

G4R-08T 900 Lm MODELS (White trim, CITIZEN LED)						
Code	LED output	Downlight output	LED Power	System Power	CRI	CCT
G4R-08T-830 Clear	1100 lm	900 lm	9.5 W	12 W	83	3000K
G4R-08T-840 Clear	1200 lm	950 lm	9.5 W	12 W	83	4000K

13 W 1000 lm-1200lm

3000K (Standard)

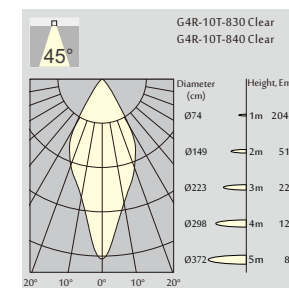
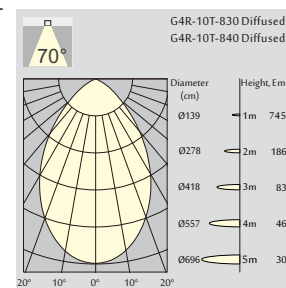

Order Information

G4R with diffused cover version

G4R-10T 1000 Lm MODELS (White trim, CITIZEN LED)						
Code	LED output	Downlight output	LED Power	System Power	CRI	CCT
G4R-10T-830 Diffused	1400 lm	1000 lm	13 W	15 W	83	3000K
G4R-10T-840 Diffused	1500 lm	1100 lm	13 W	15 W	83	4000K

G4R with clear glass version

G4R-10T 1100 Lm MODELS (White trim, CITIZEN LED)						
Code	LED output	Downlight output	LED Power	System Power	CRI	CCT
G4R-10T-830 Clear	1400 lm	1100 lm	13 W	15 W	83	3000K
G4R-10T-840 Clear	1500 lm	1200 lm	13 W	15 W	83	4000K



LED Downlight