

Galaxy series downlight is a perfect choice for hotel lighting and hospitality area.

it consists of two interchangeable versions.

- Clear glass version makes the LED light source deep recessed, which provides very low glare light.
- Diffused cover version can provide very uniform light output.



## INTERCHANGEABLE DESIGN WITH CONCEPT

**Reduce your stock for too many different LED downlights**

CITIZEN COB LED: long lifetime and high lighting quality;

COB Holder: smart design, soldering-free when changing different color temperature of LED.

Primary reflector: twist&lock design,easy to change clear glass version and diffused cover version

Secondary reflector: press& fix,easy to change different color,fulfilling lighting design and aesthetic requirement in flexible way

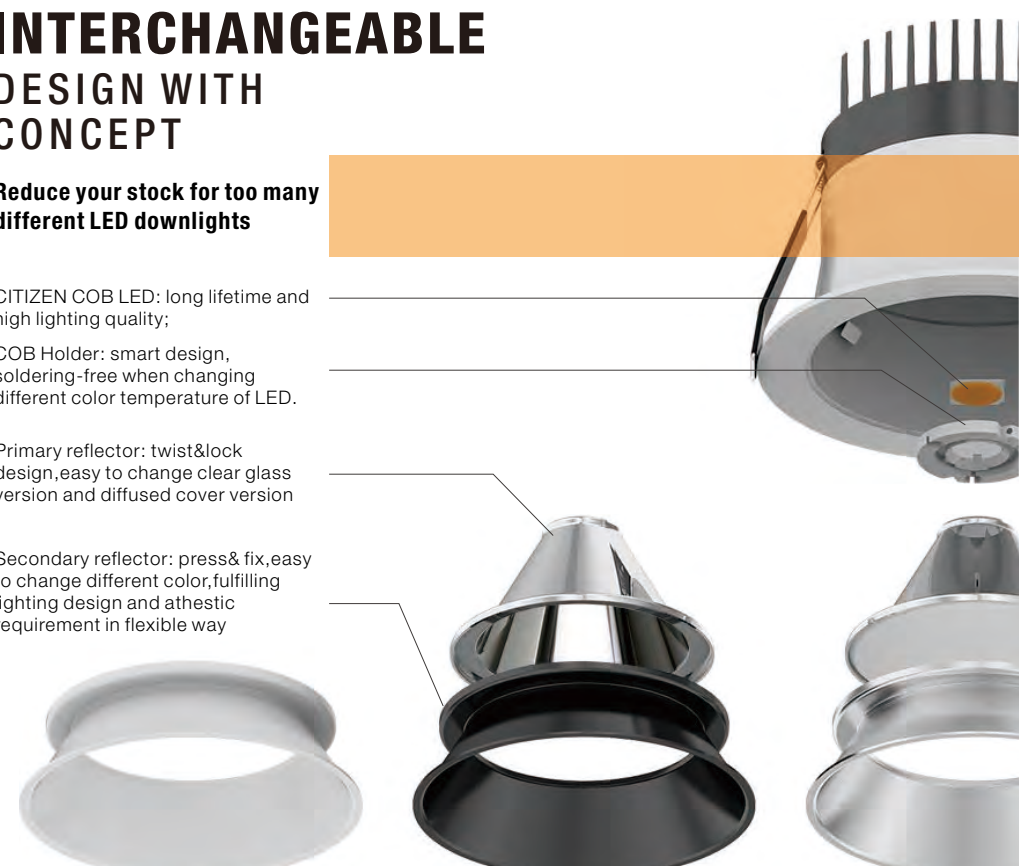



**G4**  
(800 Lm)  
(1000 Lm)



**G5**  
(1,000 Lm)  
(1,500 Lm)



**G6**  
(1,700 Lm)  
(2,300 Lm)



**G7**  
(1,700 Lm)  
(2,300 Lm)



**G8**  
(2,300 Lm)  
(3,300 Lm)

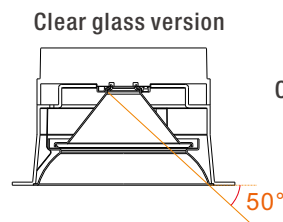

Clear glass version

Clare cut-off Angle 50°  
UGR < 19

50°

### Interchangeable Accessory

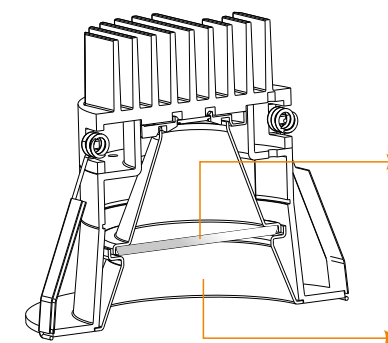

#### Primary Reflector Type



Diffused cover version    Clear glass version

#### Secondary Reflector



Silver Reflector (Standard)

White Reflector (Option)

Black Reflector (Option)



Diffused cover version



Clear glass version

### Function

- Medium size with cutout 125mm
- Perfect choice for hotel lighting and hospitality area
- Thanks to its zhaga concept designs, G5R owns high flexibility in change of reflector and LED, customer can change different accessory for different application without tool.
- Clear glass version makes the LED light source deep recessed, which provides very low glare light
- Diffused cover version can provide very uniform light output.
- Three color options for secondary reflector: Silver, Black and White - High quality CITIZEN COB chip and LED driver
- Easy replacement of CFL downlight and metal halide downlight



- Ambient operating temperature: -20°C~+40°C  
- Storage temperature: -30°C~+60°C

### LED Driver

External Driver (CE/CB/SAA certificated)  
Non-Dim: standard  
Phase Dim: optional  
1-10V /Touch /DALI Dim: on project request

### Primary Reflector Type



Diffused cover

Clear glass

### Secondary Reflector



Silver Reflector (Standard)

White Reflector (Option)

Black Reflector (Option)

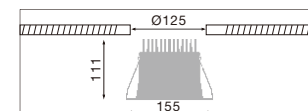

Diffused cover version



Clear glass version

### 13 W 1100 lm-1300lm

3000K (Standard)

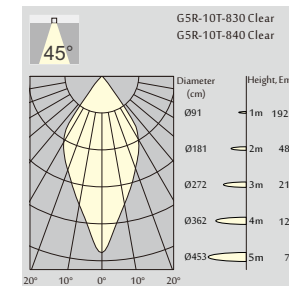
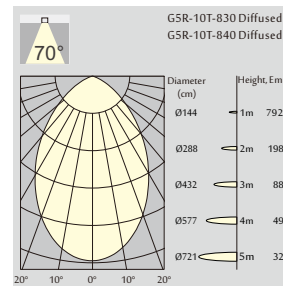

### Order Information

#### G5R with diffused cover version

G5R-10T 1100 Lm MODELS (White trim, CITIZEN LED)						
Code	LED output	Downlight output	LED Power	System Power	CRI	CCT
G5R-10T-830 Diffused	1500 lm	1100 lm	13 W	15 W	83	3000K
G5R-10T-840 Diffused	1600 lm	1200 lm	13 W	15 W	83	4000K

#### G5R with clear glass version

G5R-10T 1200 Lm MODELS (White trim, CITIZEN LED)						
Code	LED output	Downlight output	LED Power	System Power	CRI	CCT
G5R-10T-830 Clear	1500 lm	1200 lm	13 W	15 W	83	3000K
G5R-10T-840 Clear	1600 lm	1300 lm	13 W	15 W	83	4000K

### 18 W 1500 lm-1700lm

3000K (Standard)

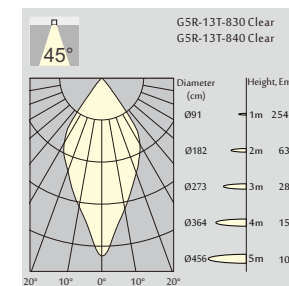
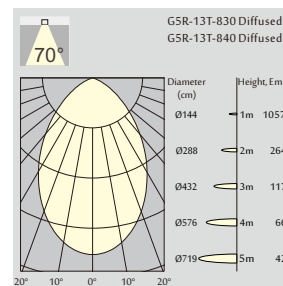

### Order Information

#### G5R with diffused cover version

G5R-13T 1500 Lm MODELS (White trim, CITIZEN LED)						
Code	LED output	Downlight output	LED Power	System Power	CRI	CCT
G5R-13T-830 Diffused	2000 lm	1500 lm	18 W	21 W	83	3000K
G5R-13T-840 Diffused	2100 lm	1600 lm	18 W	21 W	83	4000K

#### G5R with clear glass version

G5R-13T 1600 Lm MODELS (White trim, CITIZEN LED)						
Code	LED output	Downlight output	LED Power	System Power	CRI	CCT
G5R-13T-830 Clear	2000 lm	1600 lm	18 W	21 W	83	3000K
G5R-13T-840 Clear	2100 lm	1700 lm	18 W	21 W	83	4000K



LED Downlight