



Galaxy series downlight is a perfect choice for hotel lighting and hospitality area.

it consists of two interchangeable versions.

- Clear glass version makes the LED light source deep recessed, which provides very low glare light.
- Diffused cover version can provide very uniform light output.



## INTERCHANGEABLE DESIGN WITH CONCEPT

**Reduce your stock for too many different LED downlights**

CITIZEN COB LED: long lifetime and high lighting quality;

COB Holder: smart design, soldering-free when changing different color temperature of LED.

Primary reflector: twist&lock design, easy to change clear glass version and diffused cover version

Secondary reflector: press& fix, easy to change different color, fulfilling lighting design and aesthetic requirement in flexible way

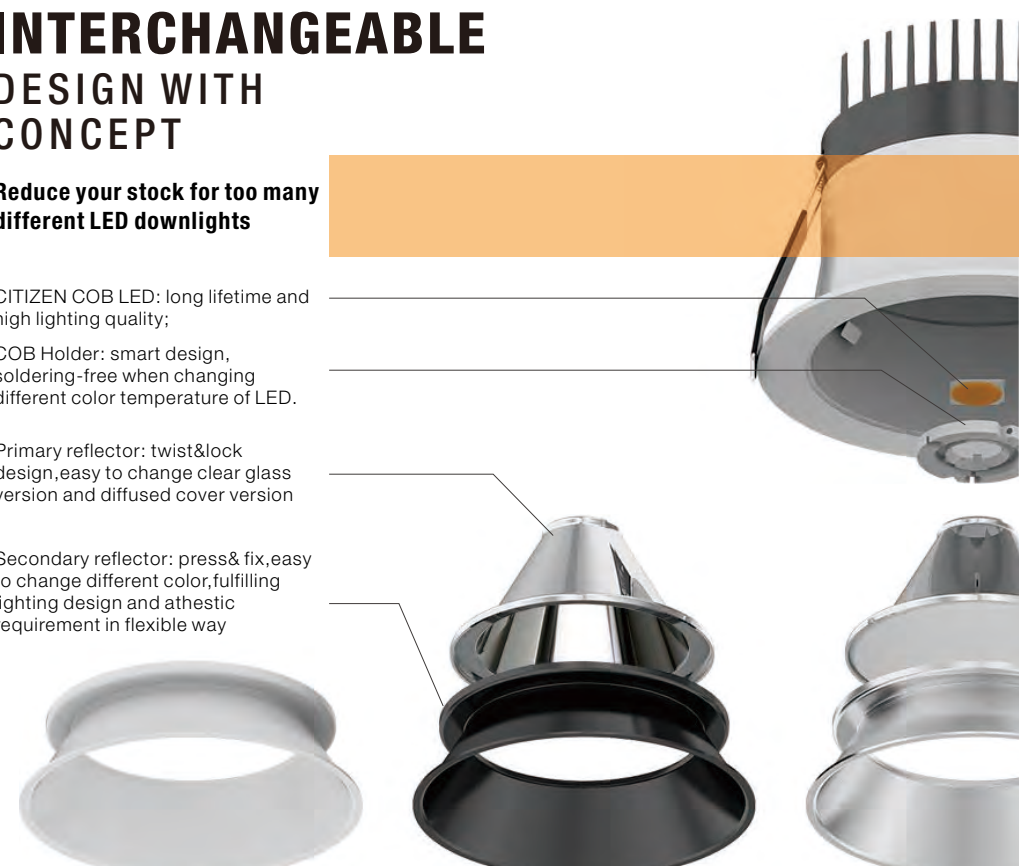



**G4**  
(800 Lm)  
(1000 Lm)



**G5**  
(1,000 Lm)  
(1,500 Lm)



**G6**  
(1,700 Lm)  
(2,300 Lm)



**G7**  
(1,700 Lm)  
(2,300 Lm)



**G8**  
(2,300 Lm)  
(3,300 Lm)



Clear glass version

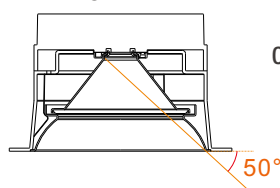

Clare cut-off Angle 50°  
UGR < 19

### Interchangeable Accessory

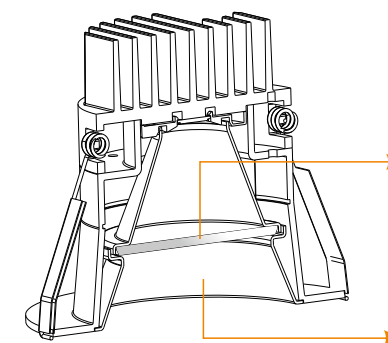

#### Primary Reflector Type



Diffused cover version    Clear glass version

#### Secondary Reflector



Silver Reflector (Standard)

White Reflector (Option)

Black Reflector (Option)

**GALAXY/G6R**  
LED Downlight



Diffused cover version



Clear glass version

**Function**

- Medium size with cutout 150mm
- Perfect choice for hotel lighting and hospitality area
- Thanks to its zhaga concept designs, G6R owns high flexibility in change of reflector and LED, customer can change different accessory for different application without tool.
- Clear glass version makes the LED light source deep recessed, which provides very low glare light
- Diffused cover version can provide very uniform light output.
- Three color options for secondary reflector: Silver, Black and White - High quality CITIZEN COB chip and LED driver
- Easy replacement of CFL downlight and metal halide downlight



- Ambient operating temperature: -20°C~+40°C  
- Storage temperature: -30°C~+60°C

**LED Driver**

External Driver (CE/CB/SAA certificated)  
Non-Dim: standard  
Phase Dim: optional  
1-10V /Touch /DALI Dim: on project request

**Primary Reflector Type**



Diffused cover

Clear glass

**Secondary Reflector**



Silver Reflector (Standard)

White Reflector (Option)

Black Reflector (Option)

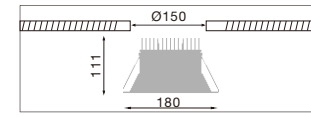

18 W 1700 lm-2000lm

3000K (Standard)

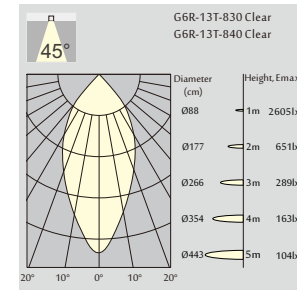
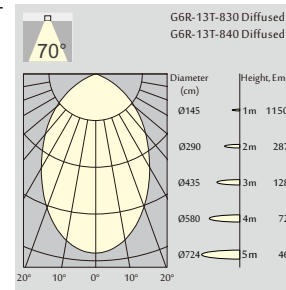

**Order Information**

**G6R with diffused cover version**

G6R-13T 1700 Lm MODELS (White trim, CITIZEN LED)

Code	LED output	Downlight output	LED Power	System Power	CRI	CCT
G6R-13T-830 Diffused	2400 lm	1700 lm	18 W	21 W	83	3000K
G6R-13T-840 Diffused	2500 lm	1800 lm	18 W	21 W	83	4000K

**G6R with clear glass version**

G6R-13T 1900 Lm MODELS (White trim, CITIZEN LED)

Code	LED output	Downlight output	LED Power	System Power	CRI	CCT
G6R-13T-830 Clear	2400 lm	1900 lm	18 W	21 W	83	3000K
G6R-13T-840 Clear	2500 lm	2000 lm	18 W	21 W	83	4000K

25 W 2300 lm-2700lm

3000K (Standard)

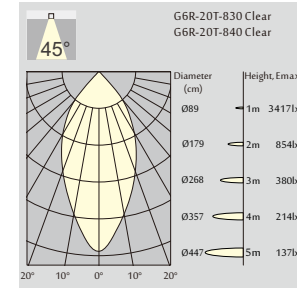
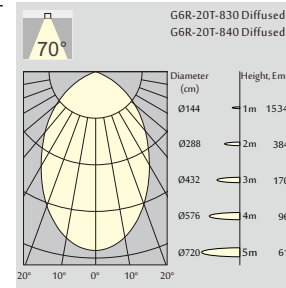

**Order Information**

**G6R with diffused cover version**

G6R-20T 2300 Lm MODELS (White trim, CITIZEN LED)

Code	LED output	Downlight output	LED Power	System Power	CRI	CCT
G6R-20T-830 Diffused	3100 lm	2300 lm	25 W	28 W	83	3000K
G6R-20T-840 Diffused	3300 lm	2500 lm	25 W	28W	83	4000K

**G6R with clear glass version**

G6R-20T 2500 Lm MODELS (White trim, CITIZEN LED)

Code	LED output	Downlight output	LED Power	System Power	CRI	CCT
G6R-20T-830 Clear	3100 lm	2500 lm	25 W	28 W	83	3000K
G6R-20T-840 Clear	3300 lm	2700 lm	25 W	28 W	83	4000K