



Galaxy series downlight is a perfect choice for hotel lighting and hospitality area.

it consists of two interchangeable versions.

- Clear glass version makes the LED light source deep recessed, which provides very low glare light.
- Diffused cover version can provide very uniform light output.



INTERCHANGEABLE DESIGN WITH CONCEPT

Reduce your stock for too many different LED downlights

CITIZEN COB LED: long lifetime and high lighting quality;

COB Holder: smart design, soldering-free when changing different color temperature of LED.

Primary reflector: twist&lock design, easy to change clear glass version and diffused cover version

Secondary reflector: press& fix, easy to change different color, fulfilling lighting design and aesthetic requirement in flexible way

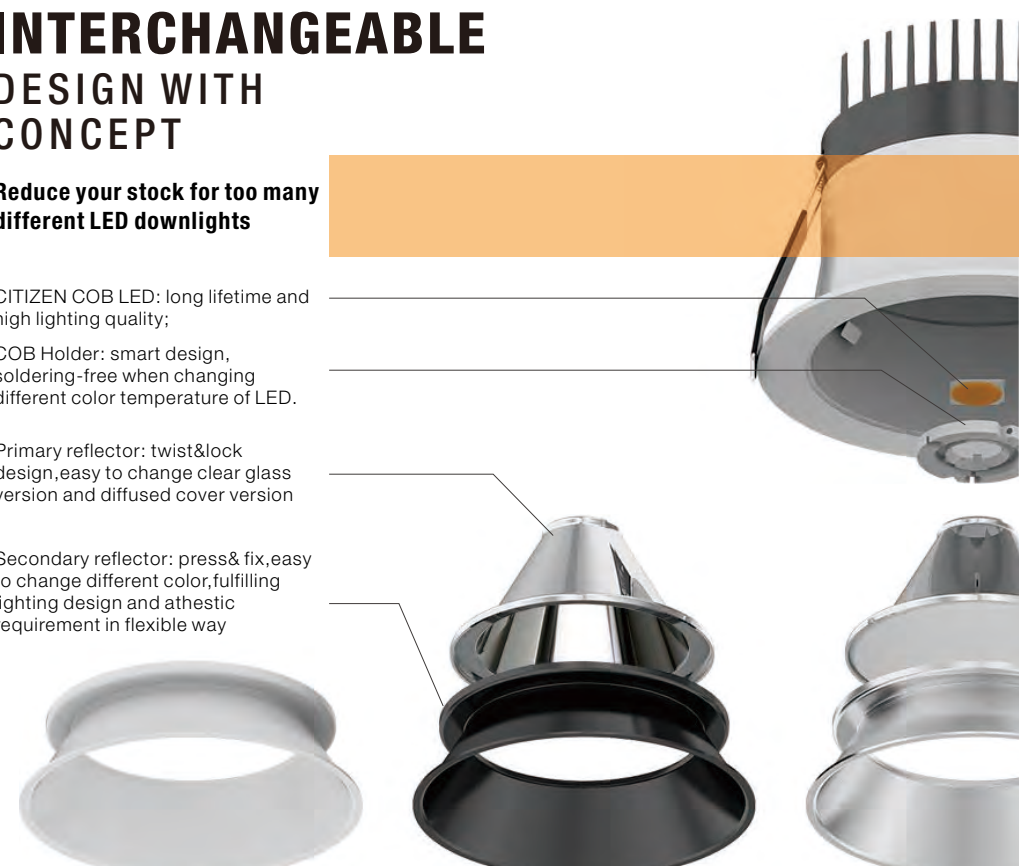



G4
(800 Lm)
(1000 Lm)



G5
(1,000 Lm)
(1,500 Lm)



G6
(1,700 Lm)
(2,300 Lm)



G7
(1,700 Lm)
(2,300 Lm)



G8
(2,300 Lm)
(3,300 Lm)



Clear glass version

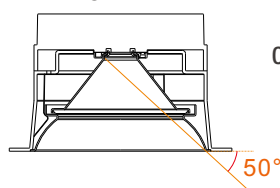

Glare cut-off Angle 50°
UGR < 19

Interchangeable Accessory

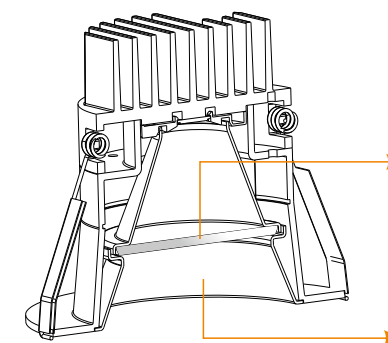

Primary Reflector Type



Diffused cover version Clear glass version

Secondary Reflector



Silver Reflector (Standard)

White Reflector (Option)

Black Reflector (Option)



Diffused cover version



Clear glass version

Function

- Medium size with cutout 175mm
- Perfect choice for hotel lighting and hospitality area
- Thanks to its zhaga concept designs, G7R owns high flexibility in change of reflector and LED, customer can change different accessory for different application without tool.
- Clear glass version makes the LED light source deep recessed, which provides very low glare light
- Diffused cover version can provide very uniform light output.
- Three color options for secondary reflector: Silver, Black and White - High quality CITIZEN COB chip and LED driver
- Easy replacement of CFL downlight and metal halide downlight



- Ambient operating temperature: -20°C~+40°C
- Storage temperature: -30°C~+60°C

LED Driver

External Driver (CE/CB/SAA certificated)
Non-Dim: standard
Phase Dim: optional
1-10V /Touch /DALI Dim: on project request

Primary Reflector Type



Diffused cover

Clear glass

Secondary Reflector



Silver Reflector (Standard)

White Reflector (Option)

Black Reflector (Option)

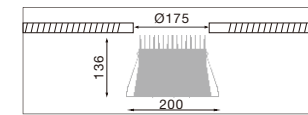
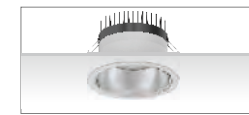

18 W 1700 lm-2000lm

3000K (Standard)

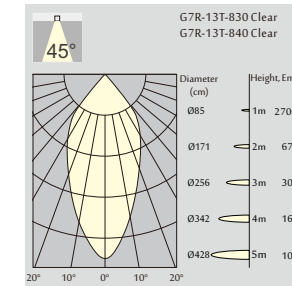
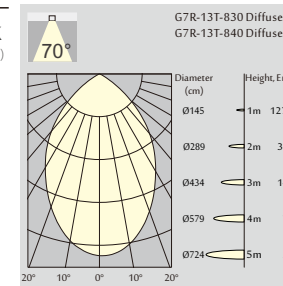

Order Information

G7R with diffused cover version

G7R-13T 1700 Lm MODELS (White trim, CITIZEN LED)						
Code	LED output	Downlight output	LED Power	System Power	CRI	CCT
G7R-13T-830 Diffused	2400 lm	1700 lm	18 W	21 W	83	3000K
G7R-13T-840 Diffused	2500 lm	1800 lm	18 W	21 W	83	4000K

G7R with clear glass version

G7R-13T 1900 Lm MODELS (White trim, CITIZEN LED)						
Code	LED output	Downlight output	LED Power	System Power	CRI	CCT
G7R-13T-830 Clear	2400 lm	1900 lm	18 W	21 W	83	3000K
G7R-13T-840 Clear	2500 lm	2000 lm	18 W	21 W	83	4000K

25 W 2300 lm-2700lm

3000K (Standard)

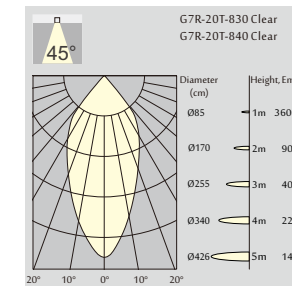
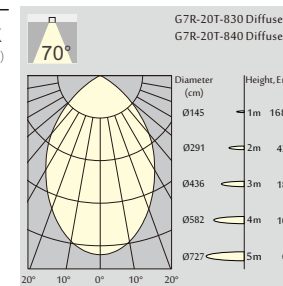

Order Information

G7R with diffused cover version

G7R-20T 2300 Lm MODELS (White trim, CITIZEN LED)						
Code	LED output	Downlight output	LED Power	System Power	CRI	CCT
G7R-20T-830 Diffused	3100 lm	2300 lm	25 W	28 W	83	3000K
G7R-20T-840 Diffused	3300 lm	2500 lm	25 W	28 W	83	4000K

G7R with clear glass version

G7R-20T 2500 Lm MODELS (White trim, CITIZEN LED)						
Code	LED output	Downlight output	LED Power	System Power	CRI	CCT
G7R-20T-830 Clear	3100 lm	2500 lm	25 W	28 W	83	3000K
G7R-20T-840 Clear	3300 lm	2700 lm	25 W	28 W	83	4000K